

User's & Administrator's Manual

KAC-SCD-10 Meeting Room Scheduler

Version 2.2

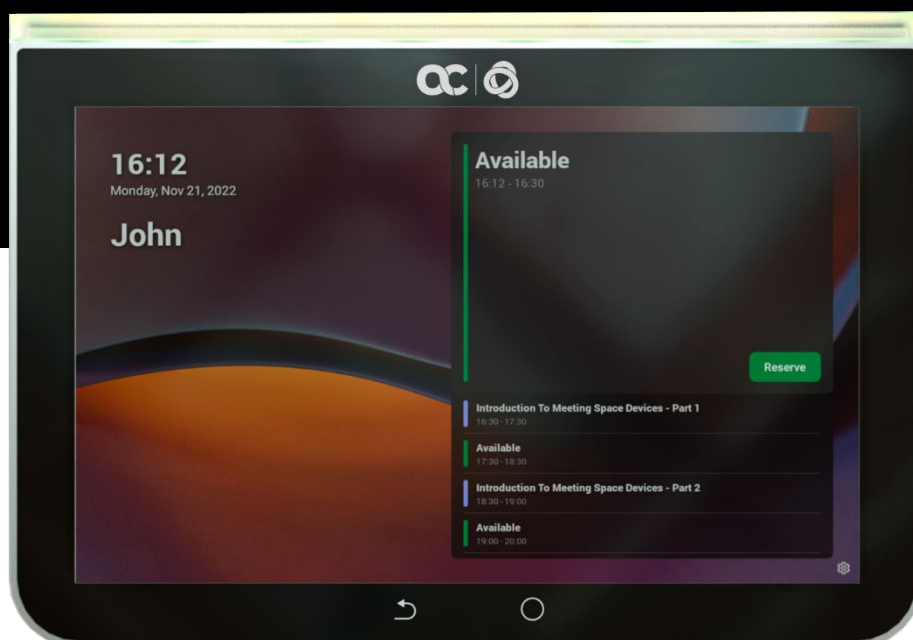

In this Manual, the following marketing names are interchangeable:

KAC-TCH-10	RX-PAD
KAC-CU-200	RXV-200
KAC-BAR-81	RXV-81
KAC-CAM-50M	RXVCam50M
KAC-CAM-CC-10	RXVCam10CC
KAC-SPK-15	RX-15
KAC-SPK-40	RX-40
KAC-SCD-10	RX-PANEL

Table of Contents

1	Introduction.....	7
1.1	Highlights	7
1.2	Specifications.....	7
2	Getting Started.....	9
2.1	Before Getting Started	9
2.2	Positioning	9
2.3	Mounting	10
2.4	Cabling.....	11
2.5	Powering up.....	11
2.6	Managing RX-PANEL	11
3	Using RX-PANEL	13
3.1	Reserving a Meeting	13
3.2	Managing a Reservation	14
3.3	Checking in	15
3.4	Configuring User Settings	16
3.4.1	Configuring Accessibility	16
3.4.2	Rebooting the Device.....	17
3.4.3	Viewing Device Information	17
3.5	Configuring Admin Settings.....	18
3.5.1	Configuring Device Administration.....	18
3.5.2	Configuring Display Settings.....	19
3.5.3	Configuring Date and Time.....	20
3.5.4	Configuring Wi-Fi	21
3.5.5	Configuring Bluetooth	22
3.5.6	Configuring USB	23
3.5.7	Configuring Power Saving	23
3.5.8	Configuring Security.....	24
3.5.9	Configuring Language & Input.....	24
3.5.10	Modifying Network	26
3.5.11	Configuring 802.1x Settings.....	27
3.5.12	Configuring VLAN Settings	28
4	Debugging.....	31
4.1	Log Settings	31
4.2	Voice Record	33
4.3	Remote Logging.....	33
4.4	Diagnostic Data.....	34
4.5	Reset configuration	34
4.6	User Data Reset	35
4.7	Restart Teams App.....	35
4.8	Debug Recording	35
4.9	Erase all data (Factory Reset).....	36
4.10	ADB	37
4.11	SSH	37
4.12	Screen Capture.....	37
4.13	Remote Packet Capture.....	37
4.14	Enabling Advanced Meeting Functions	37

This page is intentionally left blank.

Notice

Information contained in this document is believed to be accurate and reliable at the time of printing. However, due to ongoing product improvements and revisions, AudioCodes cannot guarantee accuracy of printed material after the Date Published nor can it accept responsibility for errors or omissions. Updates to this document can be downloaded from <https://www.audiocodes.com/library/technical-documents>.

This document is subject to change without notice.

Date Published: Oct-02-2023

Trademarks

AudioCodes Ltd. All rights reserved. AudioCodes, AC, HD VoIP, HD VoIP Sounds Better, IPmedia, Mediant, MediaPack, What's Inside Matters, OSN, SmartTAP, VMAS, VoIPerfect, VoIPerfectHD, Your Gateway To VoIP, 3GX, VocaNom, AudioCodes One Voice and CloudBond are trademarks or registered trademarks of AudioCodes Limited All other products or trademarks are property of their respective owners. Product specifications are subject to change without notice.

WEEE EU Directive

Pursuant to the WEEE EU Directive, electronic and electrical waste must not be disposed of with unsorted waste. Please contact your local recycling authority for disposal of this product.

Customer Support

Customer technical support and services are provided by AudioCodes or by an authorized AudioCodes Service Partner. For more information on how to buy technical support for AudioCodes products and for contact information, please visit our Web site at <https://www.audiocodes.com/services-support/maintenance-and-support>.

Stay in the Loop with AudioCodes



Abbreviations and Terminology

Each abbreviation, unless widely used, is spelled out in full when first used.

Documentation Feedback

AudioCodes continually strives to produce high quality documentation. If you have any comments (suggestions or errors) regarding this document, please fill out the Documentation Feedback form on our Web site at <http://online.audiocodes.com/documentation-feedback>.

Related Documentation

Document Name
RX-PANEL Meeting Room Scheduler Datasheet
RX-PANEL Meeting Room Scheduler Quick Guide
One Voice Operation Center (OVOC) Release Notes
One Voice Operation Center (OVOC) User's Manual
Device Manager Administrator's Manual

This page is intentionally left blank.

1 Introduction

The AudioCodes PANEL-RX Meeting Room Scheduler is a purpose-built Microsoft Teams Panel with an intuitive touchscreen display. Neatly installed right at the entrance to the meeting room, the RX-PANEL's brightly colored status LED enables users to quickly see the meeting room's availability from a distance. Users can also view the meeting details on its sleek and clear LCD screen and reserve a meeting room on the spot.

1.1 Highlights

RX-PANEL supports the following features:

- Utilizes plug-and-play simplicity to boost the meeting room experience with a dedicated panel showing the meeting details and room availability.
- Easily reserve the room for ad-hoc meetings.
- Unique, clearly-visible status LED indicating meeting space availability.
- Glass and wall mountable for a professional and spotless appearance.
- Dedicated special touch buttons (Home and Back).
- High-resolution 8-inch touchscreen.
- Runs Android 12 for improved security.
- Can be managed by AudioCodes Device Manager.

Part number: TEAMS-RX-PANEL– MSRP

1.2 Specifications

The following table shows the RX-PANEL specifications.

Feature	Description
LCD	<ul style="list-style-type: none"> • High resolution touch LCD, anti fingerprints, 1280 x 800
Built-in keys	<ul style="list-style-type: none"> • Dedicated touch keys – Home and Back
Power	<ul style="list-style-type: none"> • PoE Class 3 or external power supply
Connectivity	<ul style="list-style-type: none"> • Dual Band Wi-Fi • Bluetooth 5.0 • PoE Class 3 • Ethernet
LED	<ul style="list-style-type: none"> • RGB Status LED
Dimensions (W x H x D mm)	223.4 x 155.9 x 24.4
Weight (kg)	0.8
Mounting	Wall and glass mount (the glass option should be ordered separately)
Certifications	Microsoft Teams Rooms – coming soon Q3 2003
Compatibility	Works with Android and Windows based meeting room devices

This page is intentionally left blank.

2 Getting Started

The figure below shows the physical appearance of AudioCodes' RX-PANEL Meeting Room Scheduler.



See [here](#) for more information about the device.

2.1 Before Getting Started

Make sure you received the following in the shipped box:

- Ethernet cable
- 4 screws, 4 wall anchors, 1 template (for concrete wall mount)
- Glass-mounting bracket (for glass partition mount)



Note: Power Supply (PS) is not supplied but can be ordered separately.

2.2 Positioning

Position the device at the entrance to a conference room. Mount the device on a:

- concrete wall -or-
- glass partition



Note: Note that the device is suitable for mounting at a height no more than 2m.

2.3 Mounting

- Concrete wall (see figure below)

Use the supplied template to mark locations for 4 wall anchors; insert the 4 screws into them.

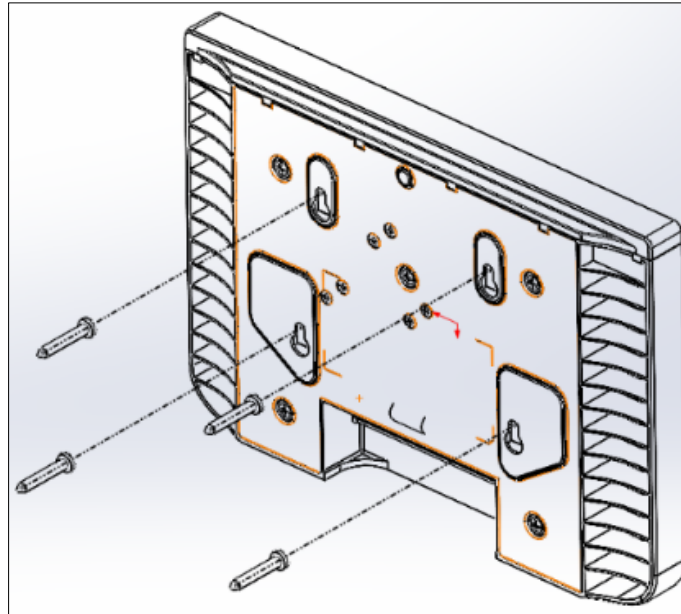

- Glass partition (see figure below)

Remove the bracket's adhesive strip cover, fix the bracket on the glass and hang RX-PANEL on it.

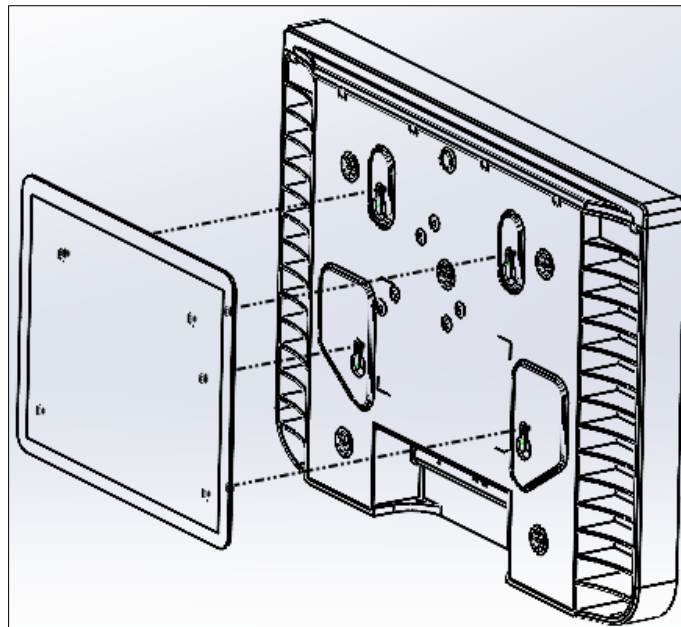

2.4 Cabling

The figures below show the RX-PANEL rear connector ports.



#	Description
1	<ul style="list-style-type: none"> The figure above left shows the ports' location (concealed view). The figure above right shows the exposed view.
2	DC jack for 12V power supply
3	Reset (Insert pin, unplug PoE, keep pin inserted, plug in PoE, keep pressing for 10 seconds)
4	Ethernet LAN/PoE GbE, RJ-45
5	USB Type C connector (for maintenance purposes) (see the <i>User's & Administrator's Manual</i>)

2.5 Powering up

Connect the RX-PANEL LAN/PoE to any PoE Ethernet switch; the unit powers up.

2.6 Managing RX-PANEL

RX-PANEL is managed by AudioCodes' One Voice Operations Center | Device Manager.

Management includes:

- Firmware management / upgrade
- Alarm management
- APK upgrade

This page is intentionally left blank.

3 Using RX-PANEL

Use the table below as reference to the following figure.



Use this table as reference to the preceding figure:

L-R	Description
1	Space availability status LED, viewable from a distance: <ul style="list-style-type: none"> Green = meeting space available; optionally reserve it right now Red or purple = meeting space unavailable Flashing red is a system status alert indicating, for example, recovery mode. Flashing green and blue indicates restore to defaults.
2	Meeting details; meeting time date organizer
3	Meeting space availability status
4	'Back' button; Tap to return to the screen previously accessed
5	All meeting spaces and availability statuses
6	Tap to reserve an available meeting space for an ad hoc meeting
7	<ul style="list-style-type: none"> Tap to return to the home screen from any screen. Long-press to access Settings.
Note: Admin can change background wallpaper color of status indicator text contrast, etc.	

3.1 Reserving a Meeting

You can reserve an ad hoc meeting when the LED is green.

➤ **To reserve an ad hoc meeting:**

1. Activate RX-PANEL.

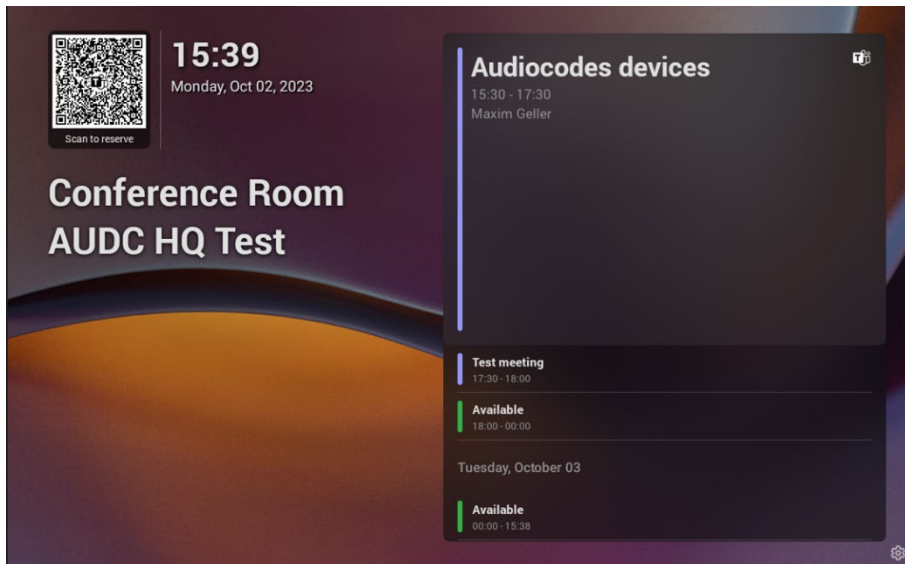

- Reserve a room using the QR Code in the home screen. RX-PANEL allows people to reserve the meeting room using the QR code. For more information about the feature, see [here](#). For information about reserving a room using QR code, see [here](#). This feature is enabled by default and can be disabled under **Device settings > Admin settings > Meetings**.
- [When RX-PANEL is paired with a Microsoft Teams Room on Android device (RXV81 - OR- RXV200), tap **Reserve**.

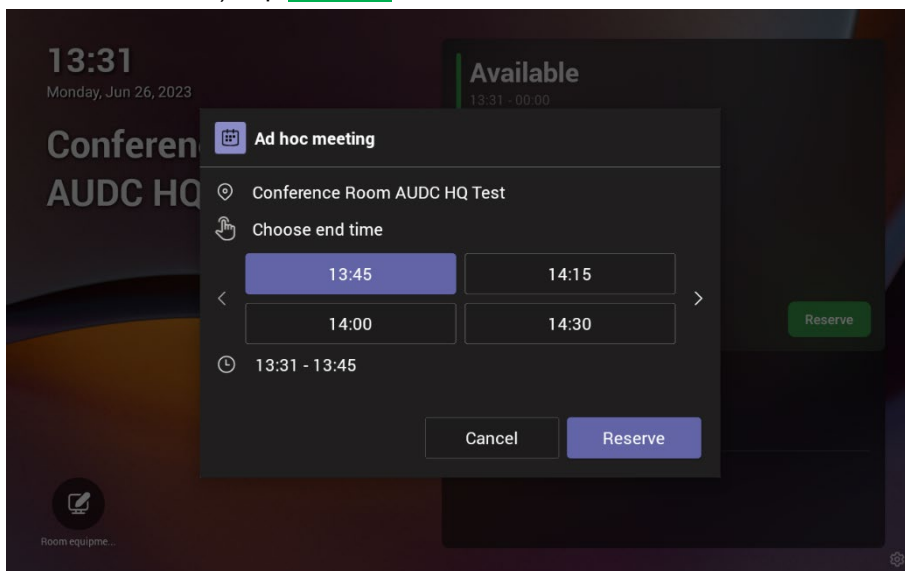

2. Tap < or > to navigate to the end time.
3. Tap **Reserve**.

3.2 Managing a Reservation

- **To manage reservation:**
 1. Activate RX-PANEL and tap **Manage**.



- 2. Tap **Check out** and in the verification prompt, tap **Check out**; this ends your room reservation.
- 3. Optionally, tap **Extend room reservation**.

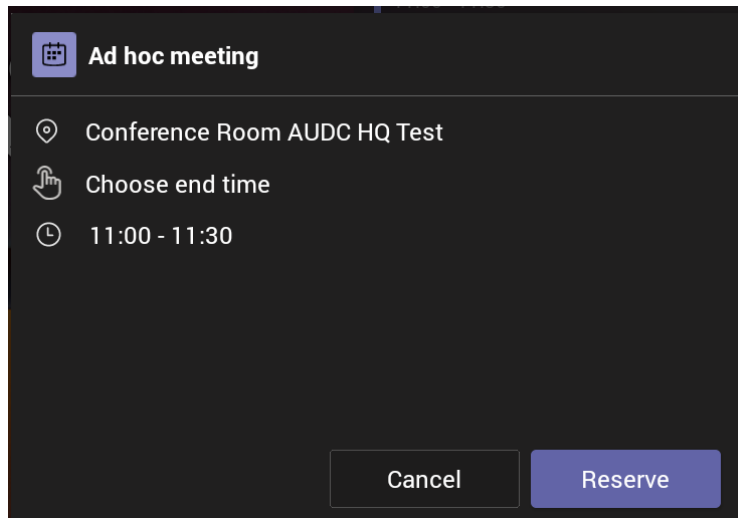

- 4. Choose the end time and then tap **Reserve**.

3.3 Checking in

➤ **To check in:**

- 1. Activate RX-PANEL.

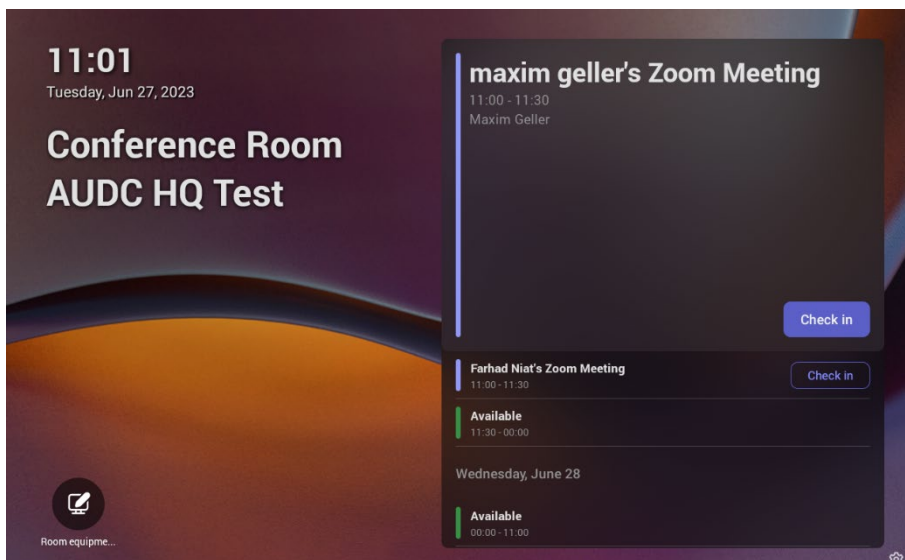

- 2. Tap **Check in**

3.4 Configuring User Settings



Note: Long-press the  button on the device.

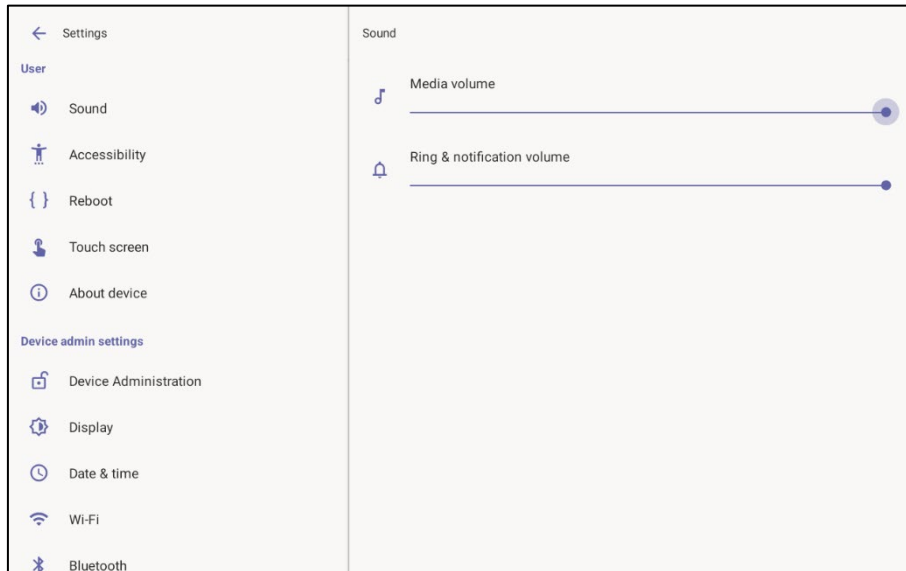

3.4.1 Configuring Accessibility

RX-PANEL features an accessibility service that allows low-vision users to interact with the device without difficulty. The feature improves the experience of these users.

➤ **To configure Accessibility:**

1. Under 'User' settings, tap **Accessibility**.

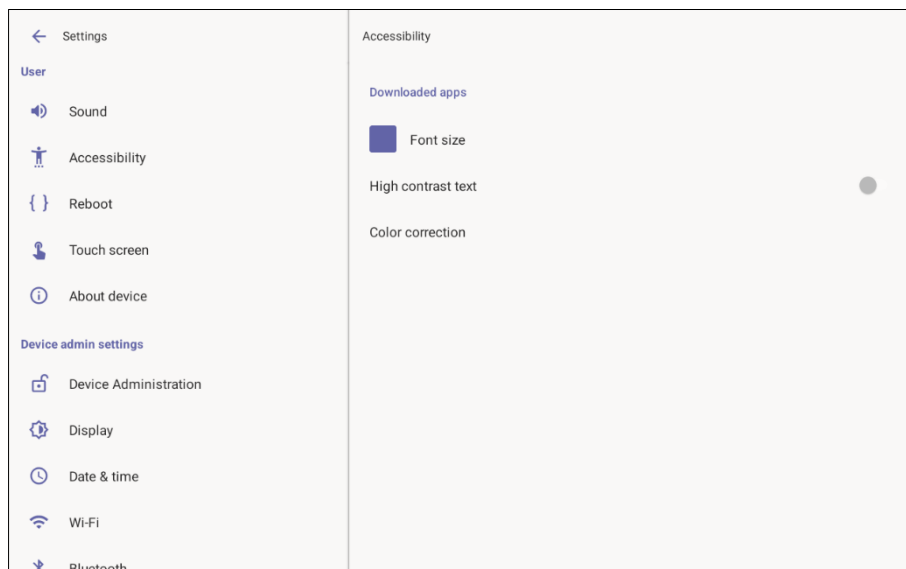

2. Adjust the font size according to preference.
3. Adjust the contrast according to preference.
4. Adjust the color correction according to preference.

3.4.2 Rebooting the Device

You can reboot the device.

➤ **To reboot the device:**

1. Under 'User' settings, tap the **Reboot** setting.

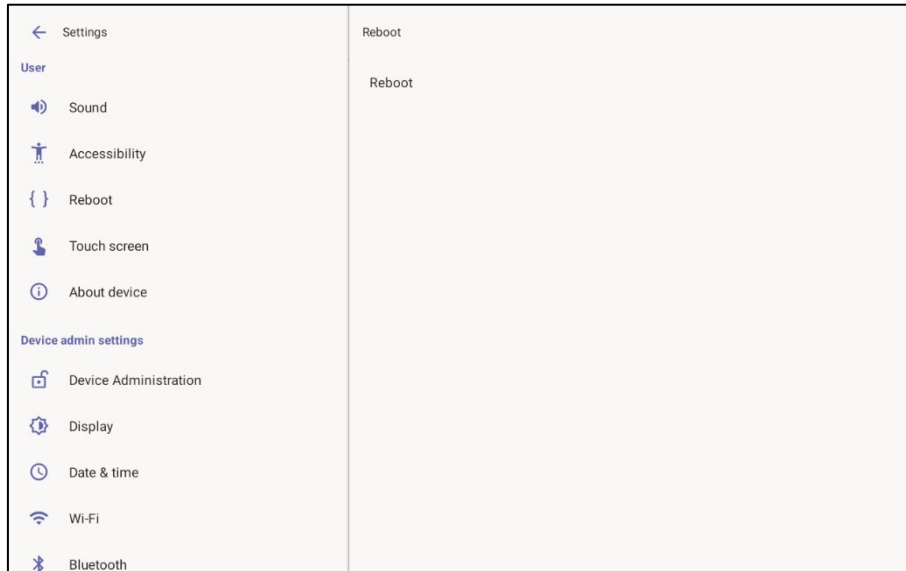

2. Tap **Reboot** and in the verification prompt displayed, tap **OK**.

3.4.3 Viewing Device Information

You can view information about the device.

➤ **To view information about the device:**

1. Under 'User' settings, tap **About device**.

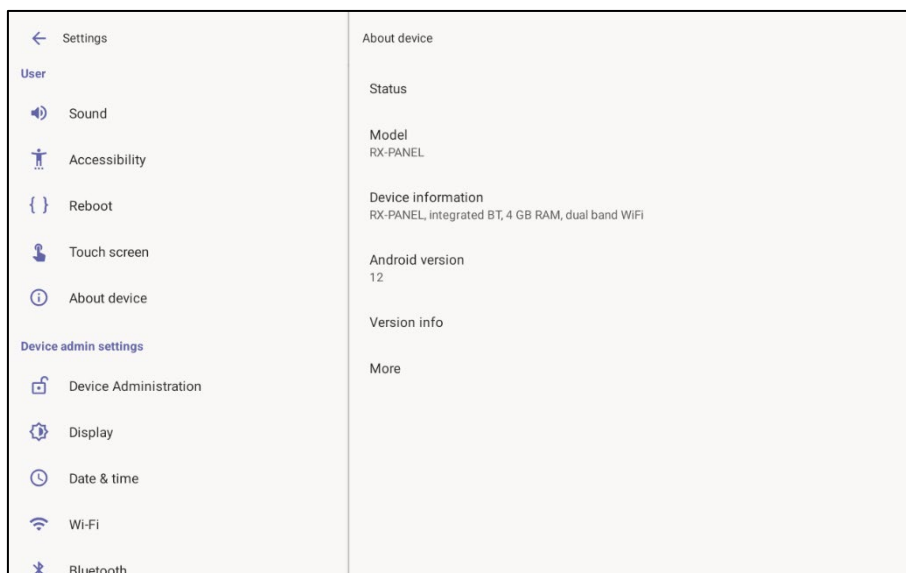

2. Tap **More** to display more information.

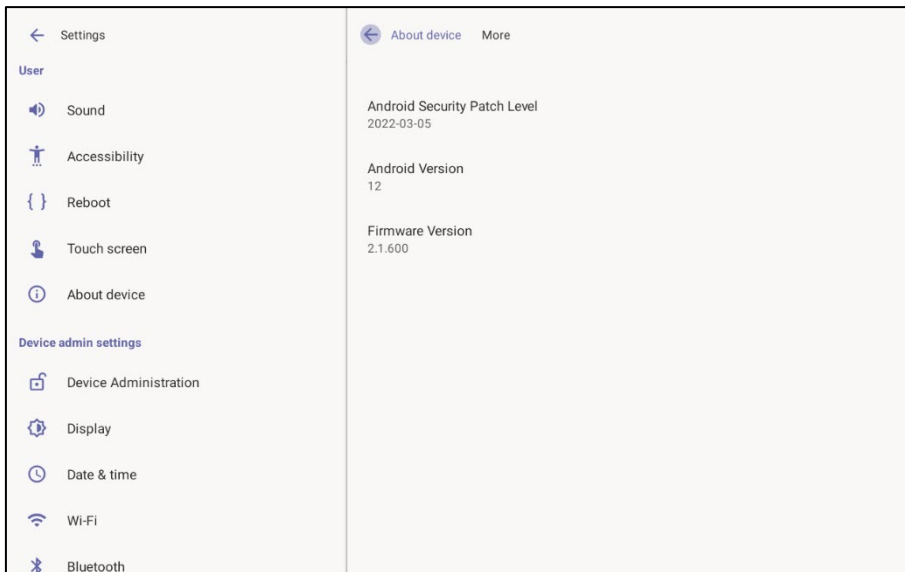

3. Tap Status.

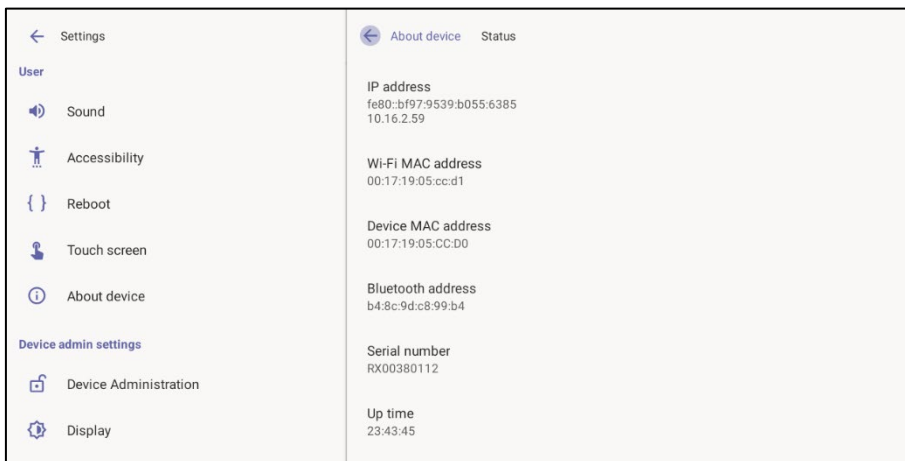

3.5 Configuring Admin Settings

3.5.1 Configuring Device Administration

➤ **To configure device administration:**

1. Under 'Device admin settings', tap **Device Administration**.

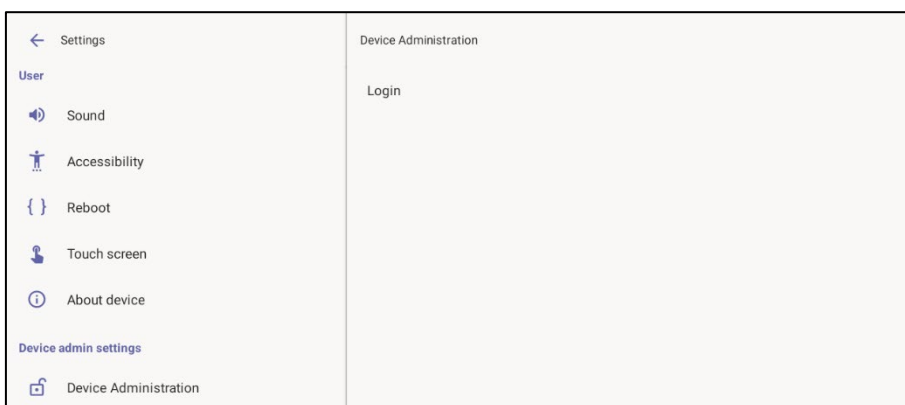

2. Tap **Login**, enter your password using the virtual keyboard displayed, and then tap **OK**.

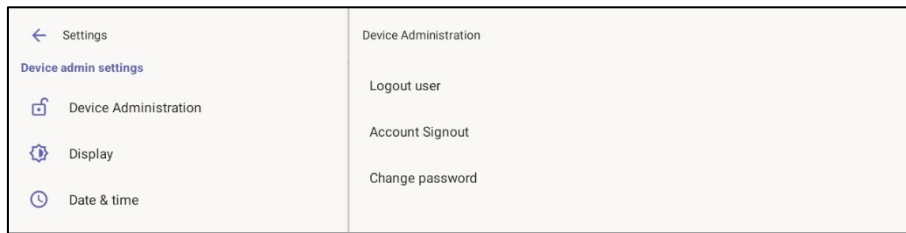

3. Tap **Logout user** to log out.
4. Tap **Account Signout** to sign out from Teams.
5. Tap **Change password** to replace your old password with a new one. Use the virtual keyboard displayed to define the old and the new.

3.5.2 Configuring Display Settings

➤ **To configure display settings:**

1. Under 'Device admin settings', tap **Display**.

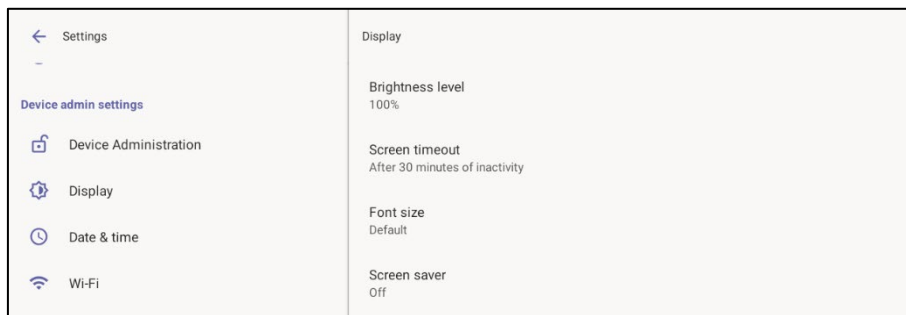

2. Tap the **Brightness level** scale to decrease or increase screen brightness.
3. Tap **Screen timeout**.

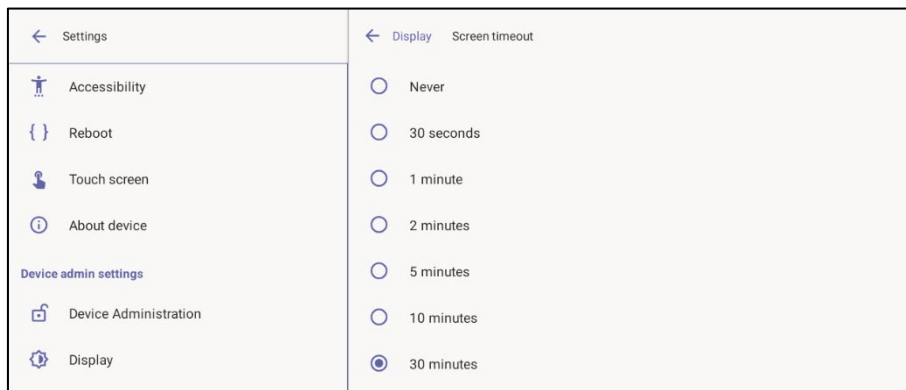

4. Tap the option of your choice and then tap ← to go back to the previous screen.
5. Tap **Font size** to make the text on the screen smaller or larger than the default and then tap ← to go back to the previous screen.
6. Tap **Screen saver**.

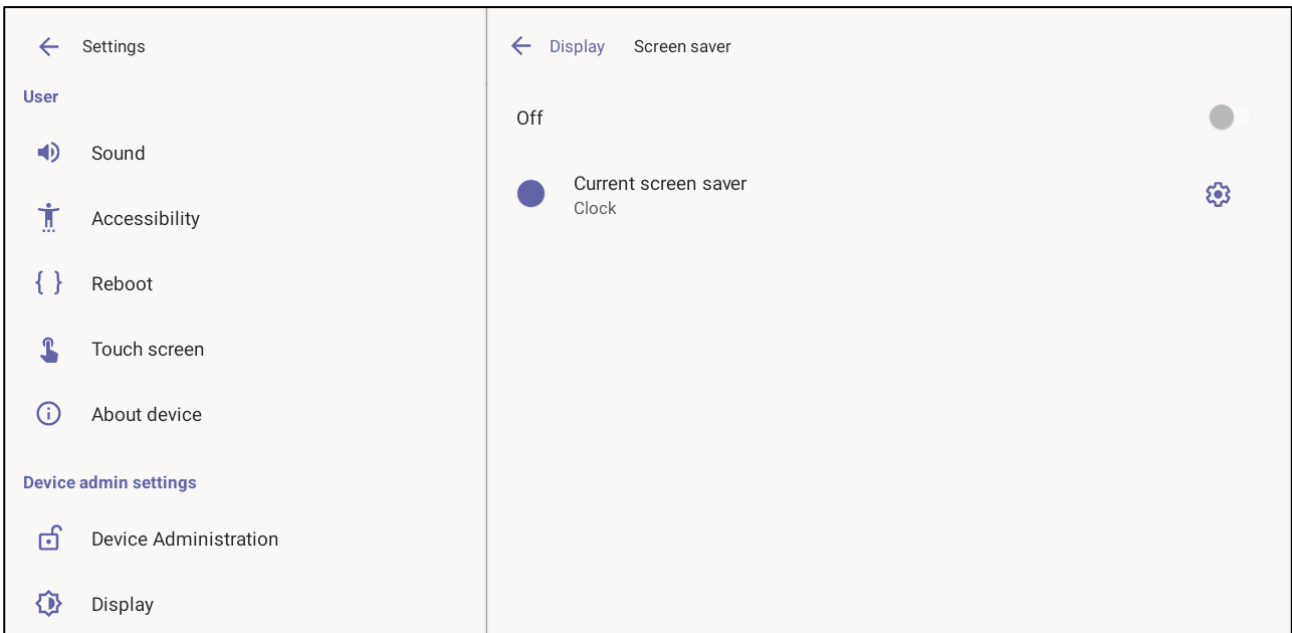

7. Tap **Off** to activate (or **On** to deactivate).
8. Tap **Current screen saver** to change **Clock > Colors** or **Colors > Clock** depending on your preference and then tap ← to go back.

3.5.3 Configuring Date and Time

➤ **To configure date and time:**

1. Under 'Device admin settings', tap **Date & time**.

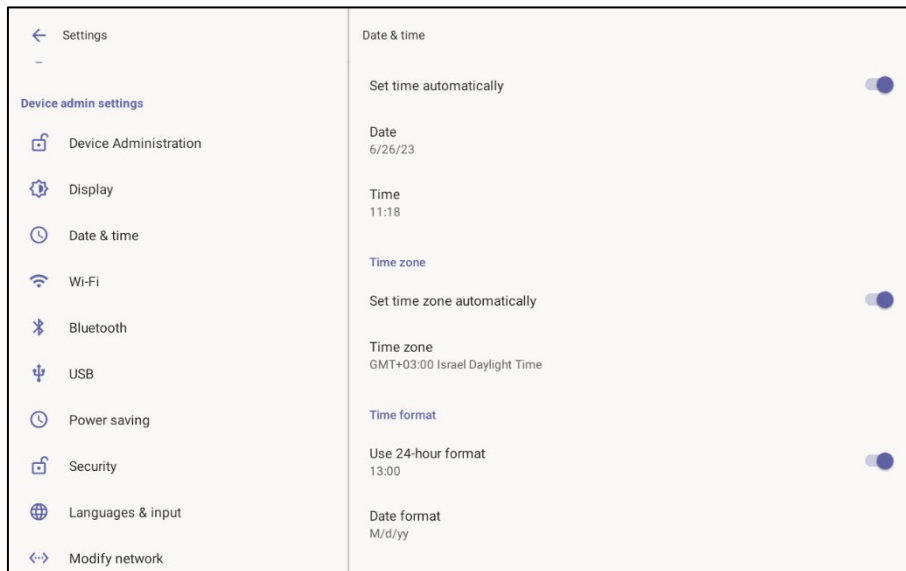

2. Activate **Set time automatically** for date and time to automatically be retrieved from the deployed Network Time Protocol (NTP) server. If this setting is activated, the following two settings (Date and Time) will be read only.
3. Tap **Date** to manually set the date in the calendar that is displayed.
4. Tap **Time** to manually set the time on the clock that is displayed.
5. Activate **Set time zone automatically** for the time zone to automatically be detected. If this setting is activated, the following setting (**Time zone**) will be read only.



Note: AudioCodes' devices feature an Automatic Time Zone Detection mechanism that allows the device to automatically detect the time zone via geographical location.

6. Tap **Time zone** if the previous setting **Set time zone automatically** is deactivated.

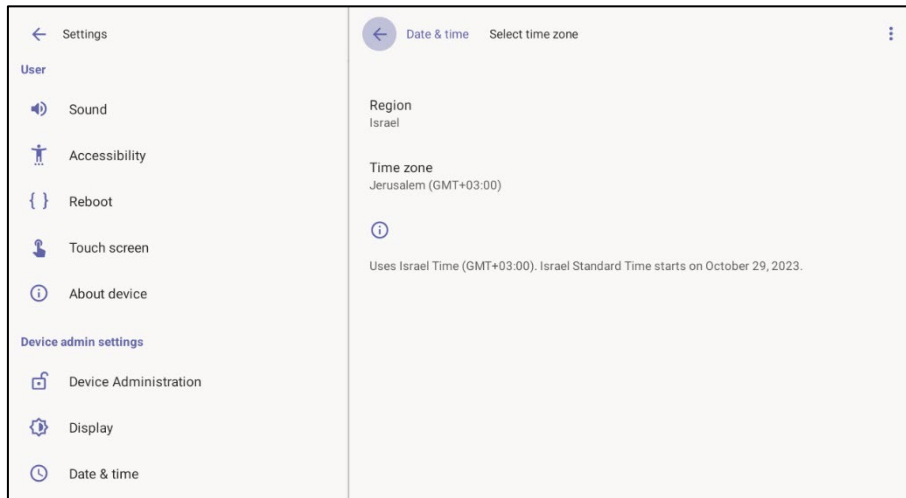

7. Tap **Region** and select the region in which you are located; the **Time zone** setting will be read only.

3.5.4 Configuring Wi-Fi

Admins can configure the device's Wi-Fi settings. The settings are concealed from the user's view.



Note: The Wi-Fi connection is transparent to users; which frequency is used, 2.4 GHz or 5 GHz, is made for users by the device; users cannot disable one or the other.

➤ To configure Wi-Fi:

1. Under 'Device admin settings', tap **Wi-Fi**.

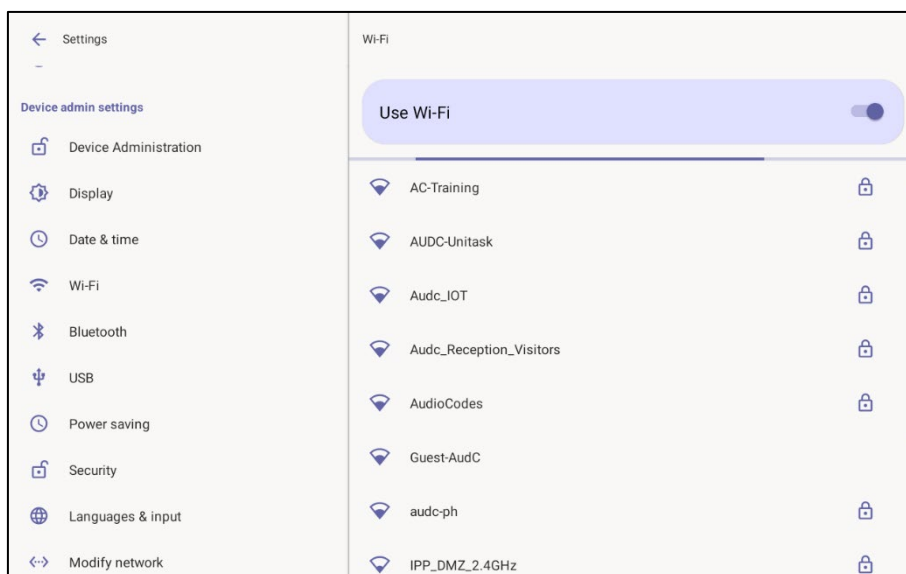

2. Activate **Use Wi-Fi** and then view a list of available connections.

3. Select the Wi-Fi network you want and then use the virtual keyboard displayed to enter the password.

3.5.5 Configuring Bluetooth

Admins can configure the device's Bluetooth settings. Hands free profile where the phone is able to connect to Bluetooth headset or speaker.

➤ **To configure Bluetooth:**

1. Under 'Device admin settings', tap **Bluetooth**.

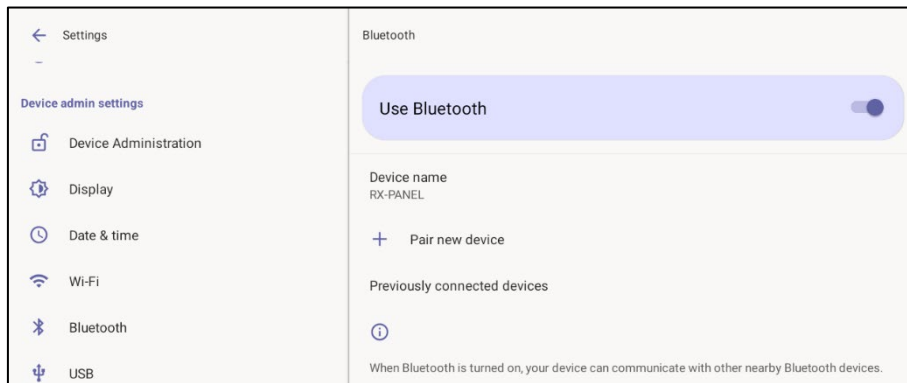

2. Activate **Use Bluetooth** and then tap **+ Pair new device**.

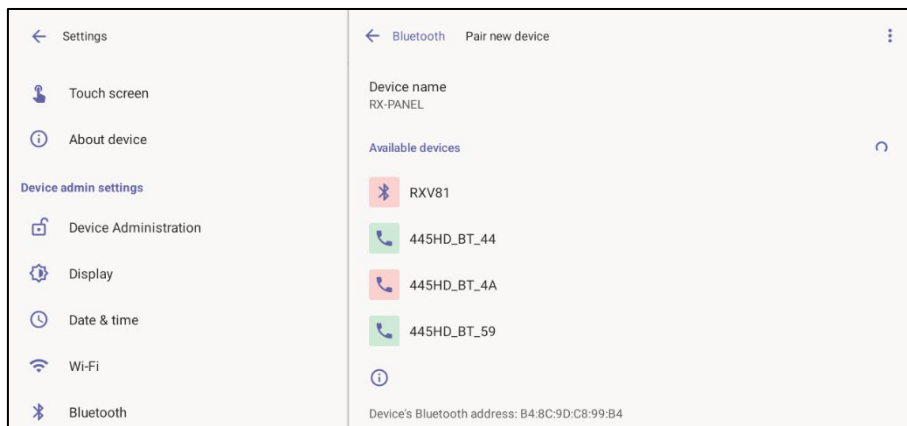

3. Tap a device with which to pair RX-PANEL.

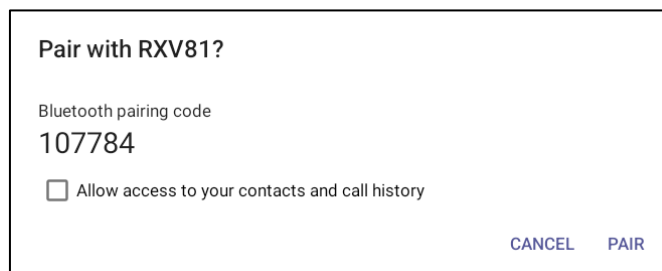

4. Tap **PAIR**.

3.5.6 Configuring USB

➤ **To configure USB:**

1. Under 'Device admin settings', tap **USB**.

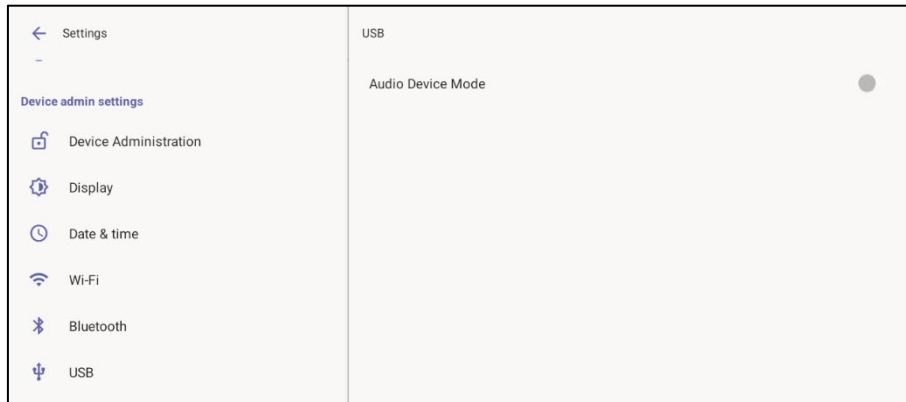

2. Activate **Audio Device Mode** and then tap ← to go back.

3.5.7 Configuring Power Saving

➤ **To configure Power Saving:**

1. Under 'Device admin settings', tap **Power Saving**.

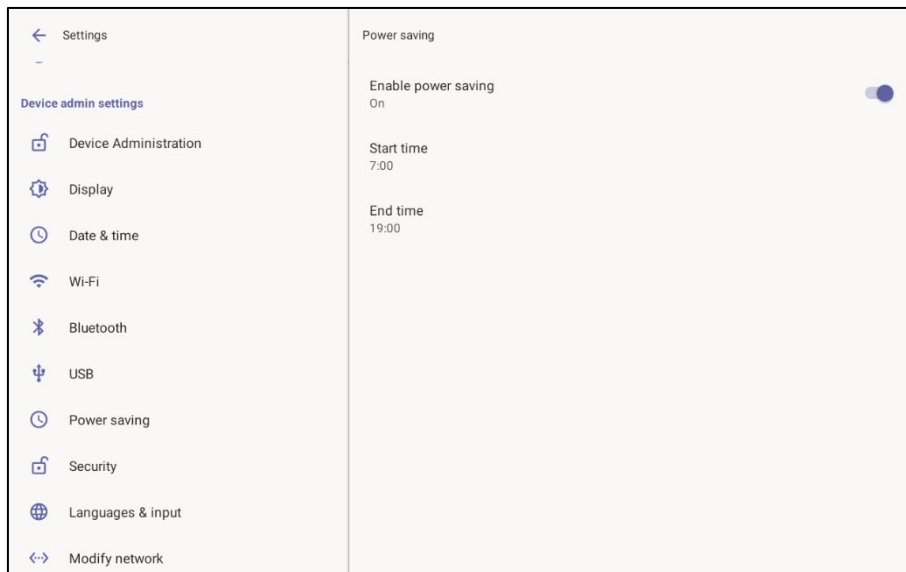

2. Activate **Power Saving** and then configure **Start time** and then **End time**.
3. Tap ← to go back.

3.5.8 Configuring Security

➤ **To configure Security:**

1. Under 'Device admin settings', tap **Security**.

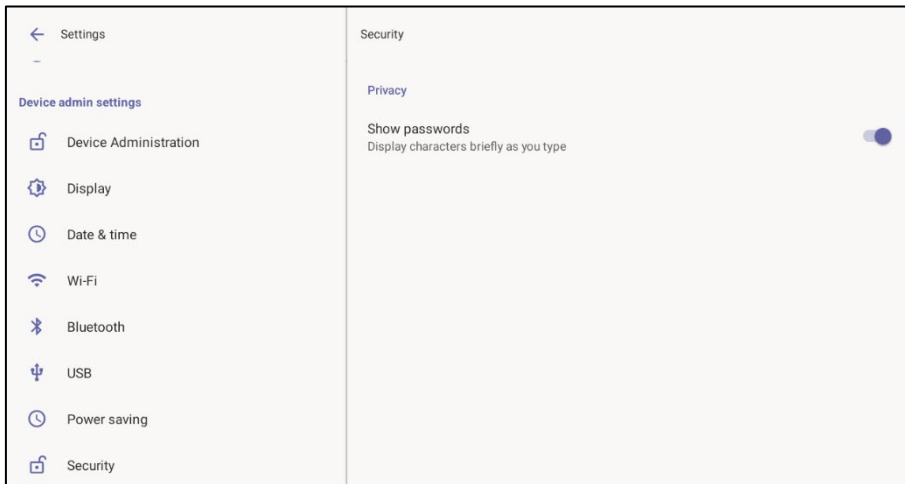

2. Under **Privacy**, activate/deactivate **Show passwords**.
3. Tap ← to go back.

3.5.9 Configuring Language & Input

➤ **To configure Language & Input:**

1. Under 'Device admin settings', tap **Language & Input**.

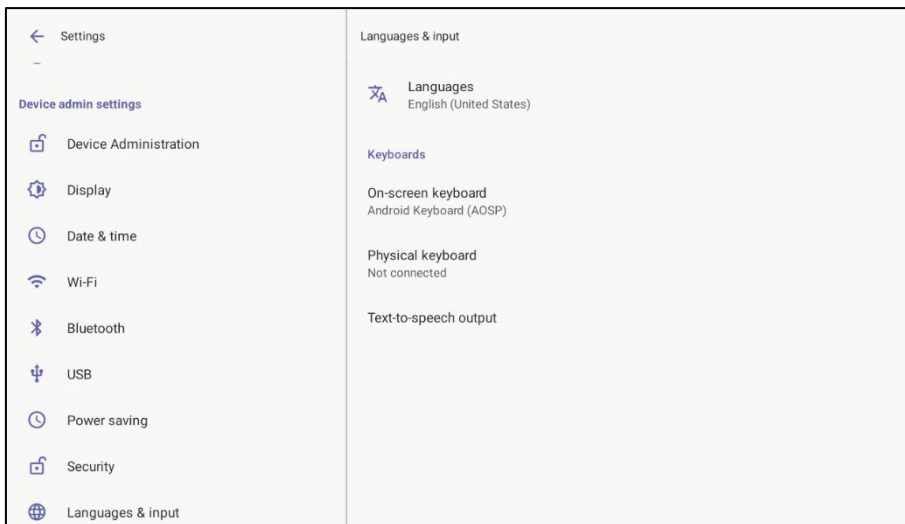

2. Touch **Languages**.

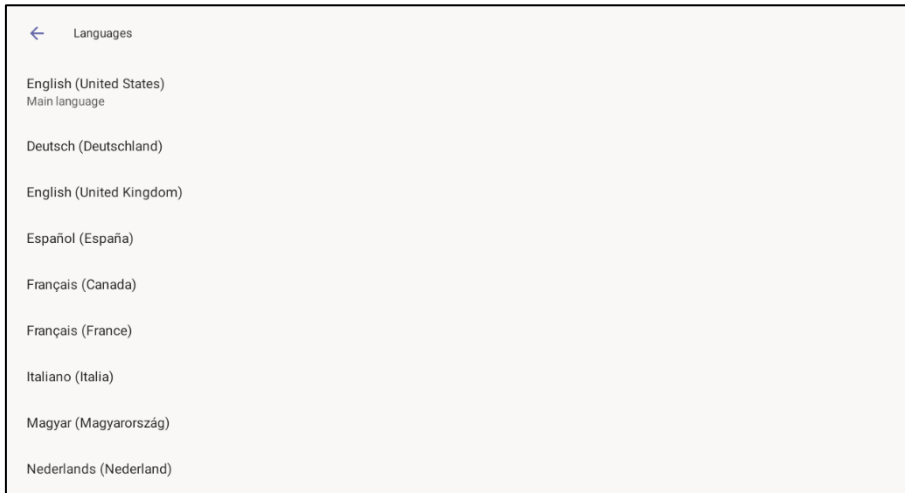

3. Select a language and then view the **Changing language for Teams app** counter displayed until the language is changed. Tap ← to go back.

4. Tap **Manage on-screen keyboards**.

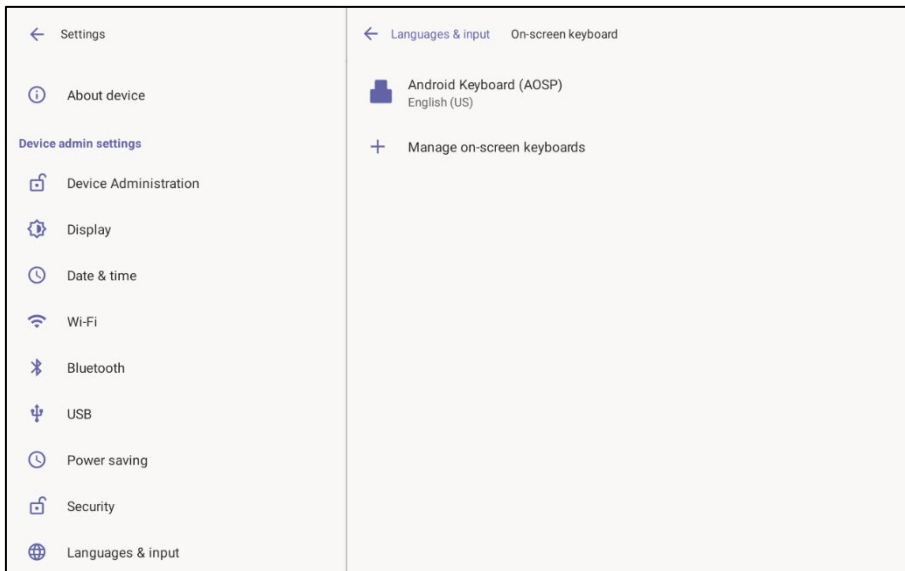

5. Define settings under 'Preferences' and 'Advanced' if necessary.

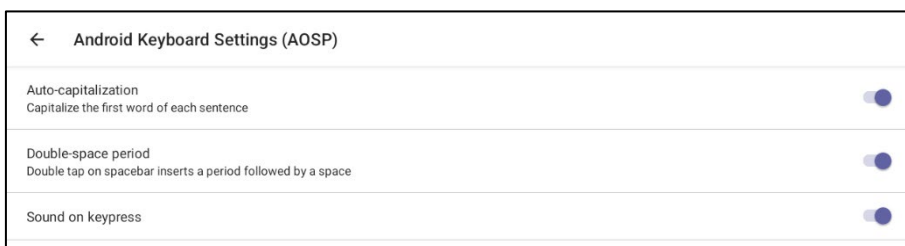

- Configure your keyboard preferences, tap ← to go back and then tap **Advanced**.



- Tap ← to go back and then again tap **Languages & input**.

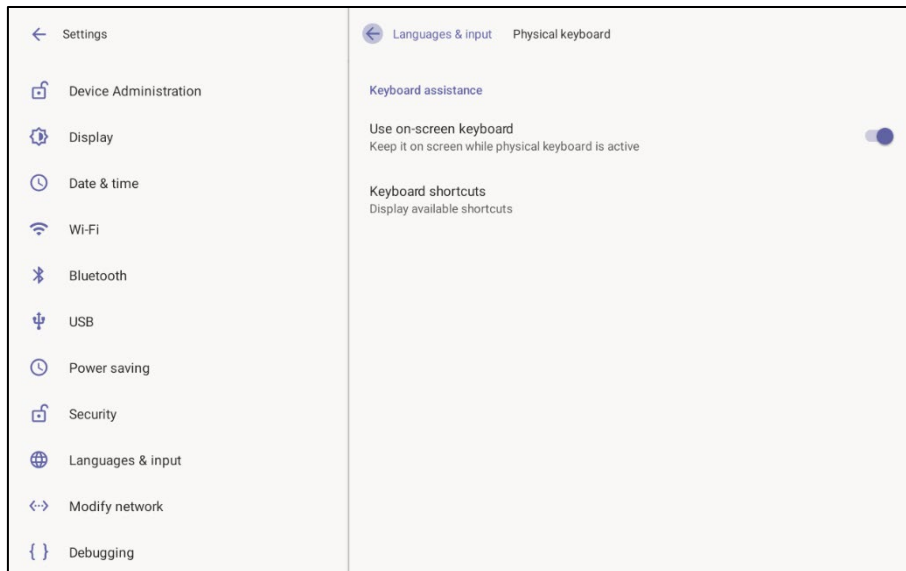

3.5.10 Modifying Network

Enables admins to determine network information and to modify network settings.

➤ **To modify network settings:**

- Under 'Device admin settings', tap **Modify Network**.

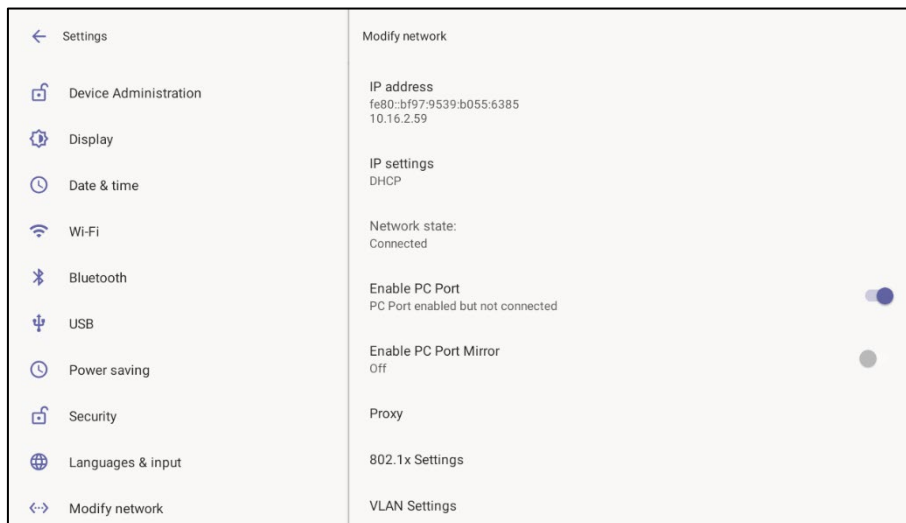

- View read-only settings **IP address**, **IP settings** and **Network state**.
- Tap **IP settings**.

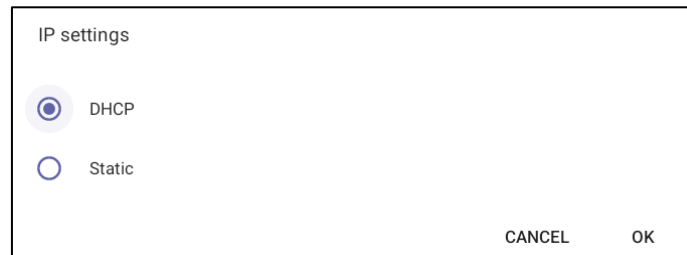

4. Select **DHCP** or **Static** and tap **OK**.
5. Tap **Enable PC Port** to enable the PC port. Tap **Enable PC Port Mirror** to enable PC port mirror. RX-PANEL supports the port mirroring network monitoring technique of copying and sending network packets transmitted as input from a device port to another port of a monitoring device for enhanced analysis and debugging capability.
6. Tap **Proxy** to configure RX-PANEL with an HTTP Proxy server.

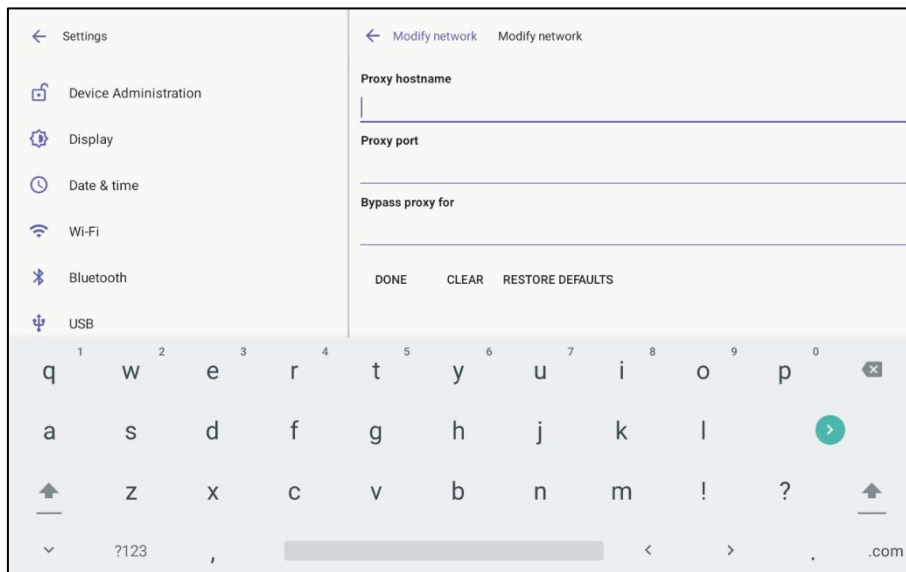

7. Tap ← to go back.

3.5.11 Configuring 802.1x Settings

Admins can configure 802.1x Settings.

➤ **To configure 802.1x settings:**

1. Under 'Device admin settings', tap **802.1x Settings**.

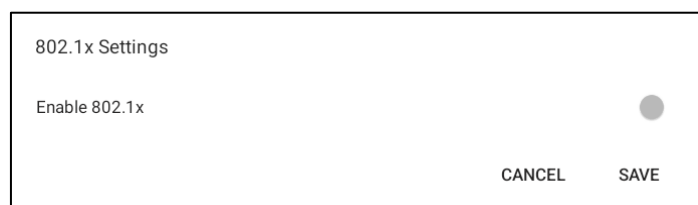

2. Tap **Enable 801.1x** and then tap **Save**.

3.5.12 Configuring VLAN Settings

Admins can configure VLAN Settings. VLAN Settings allow you to configure the VLAN mode **Manual**, **CDP only** or **LLDP only**. Note that LLDP switch information is retrieved (for location purposes) when parameter network/lan/lldp/enabled=1 (even when VLAN is retrieved from **CDP** or VLAN is disabled or VLAN is **Manual**).

➤ **To configure VLAN settings:**

1. Under 'Device admin settings', tap **VLAN Settings**.

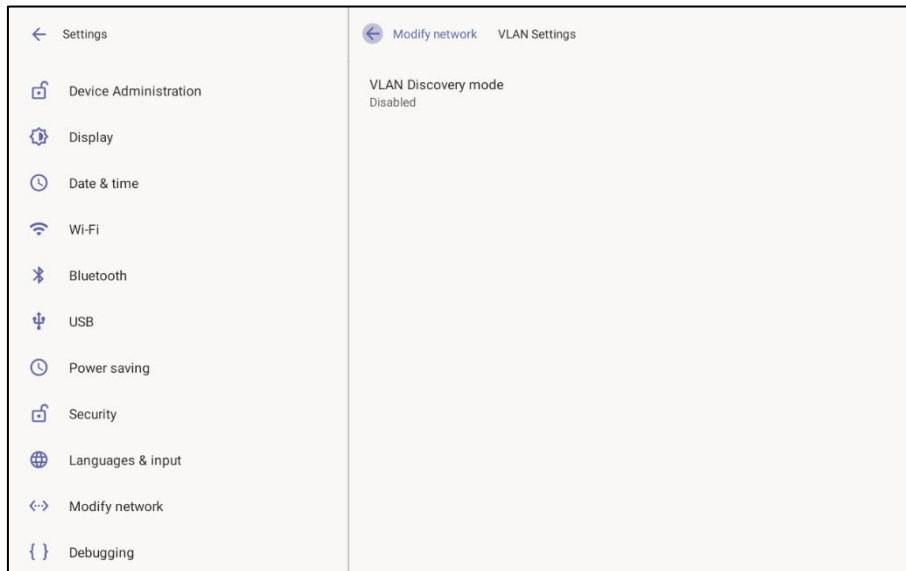

2. Tap **VLAN Discovery mode**.

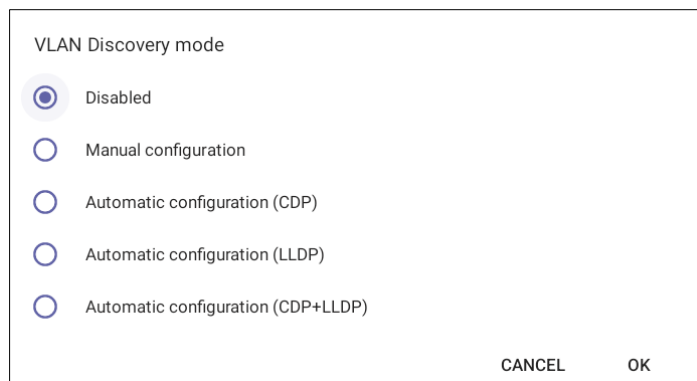

- Cisco Discovery Protocol (**CDP**) is a Cisco proprietary Data Link Layer protocol
 - Link Layer Discovery Protocol (**LLDP**) is a standard, layer two discovery protocol
3. Select the mode you require and then tap OK. If you select **Manual configuration**, this screen opens:

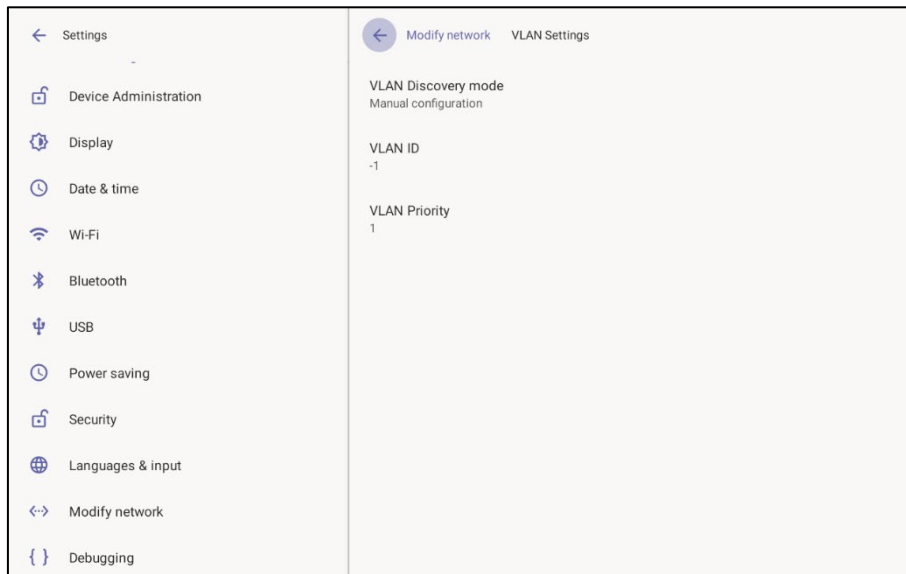

4. Tap **VLAN ID**.

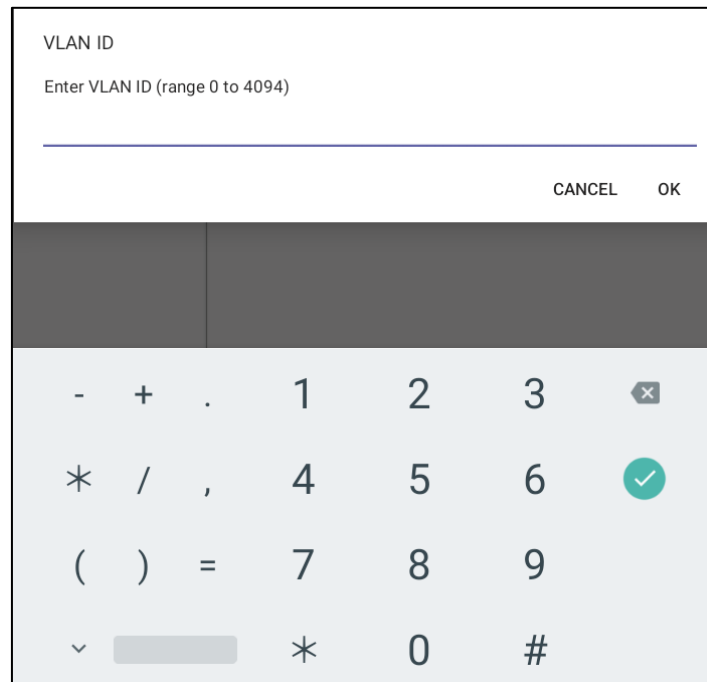

5. Enter the VLAN ID (range 0-4094) using the virtual keyboard and then tap **OK**.
6. Tap **VLAN Priority**.

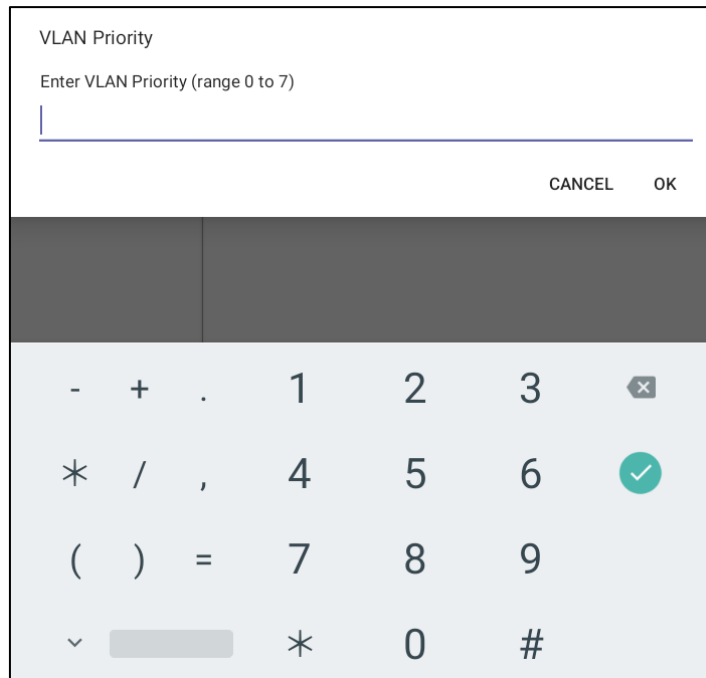

7. Enter the VLAN Priority (range 0-7) using the virtual keyboard and then tap **OK**.

4 Debugging

- AudioCodes RX-PANEL leverages SSH as a debugging interface.
- AudioCodes recommends that customers disable SSH on RX-PANEL via AudioCodes' Device Manager (OVOC).
- AudioCodes recommends changing the Admin password from the default, via AudioCodes' Device Manager (OVOC).
- When RX-PANEL - or multiple RX-PANELs - needs to be debugged, users can enable SSH on it / them, access SSH with the new Admin password for the debugging phase, and disable SSH once debugging is finished.



Note: SSH is by default disabled and can be enabled with Administrator permissions in the RX-PANEL screen (**Device Administration > Debugging > SSH**).

4.1 Log Settings

Admins can configure log settings such as Log Level, Log Package Filter, Log Tag Filter and Log Buffer Filter.

➤ **To log settings:**

1. Tap **Log settings**.

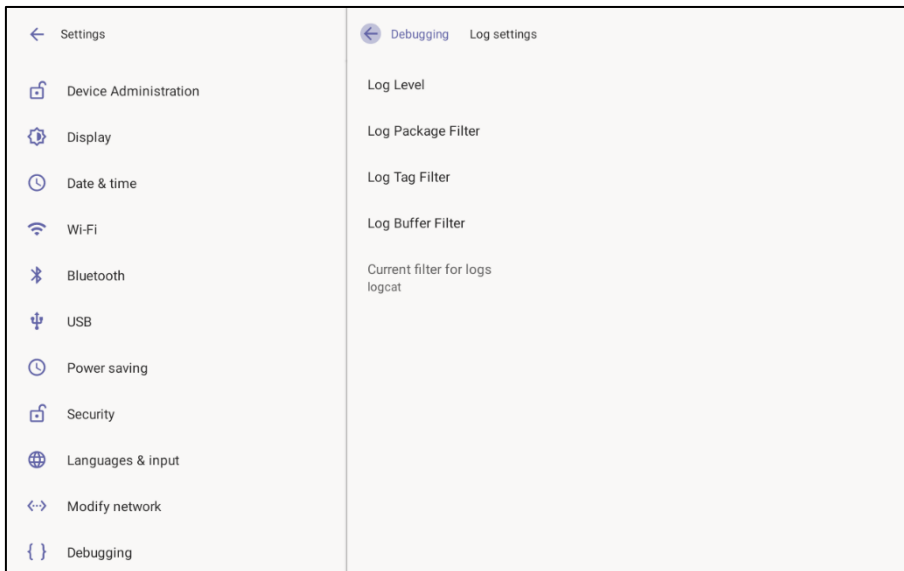

2. Tap **Log Level**.

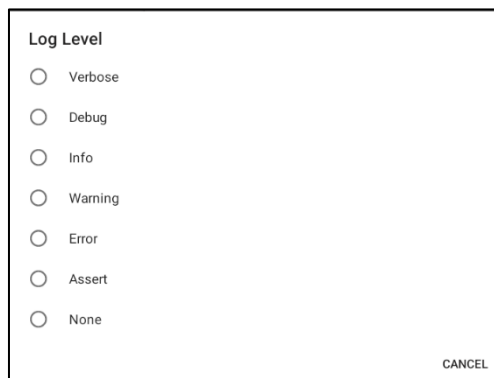

3. Tap the level you require.
4. Tap **Log Package Filter**.

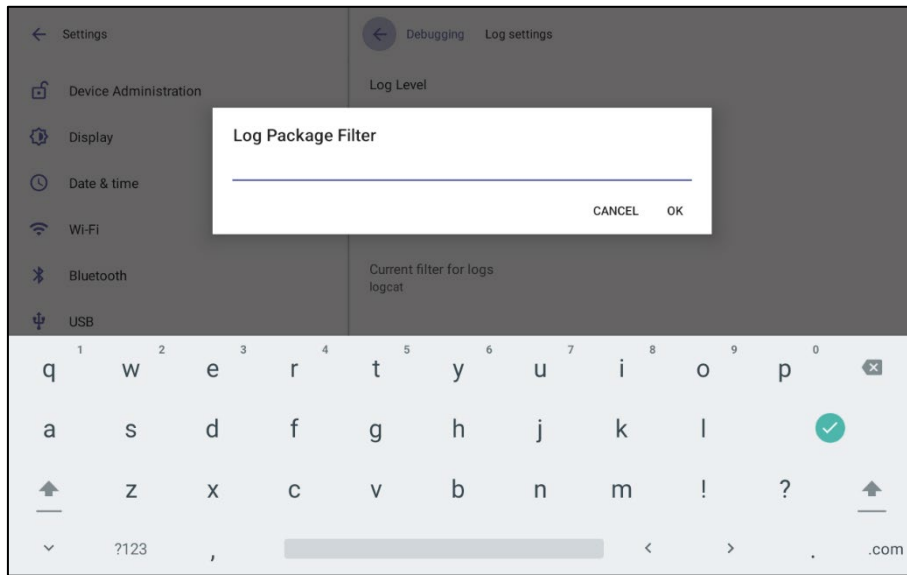

5. Tap **Log Tag Filter**.

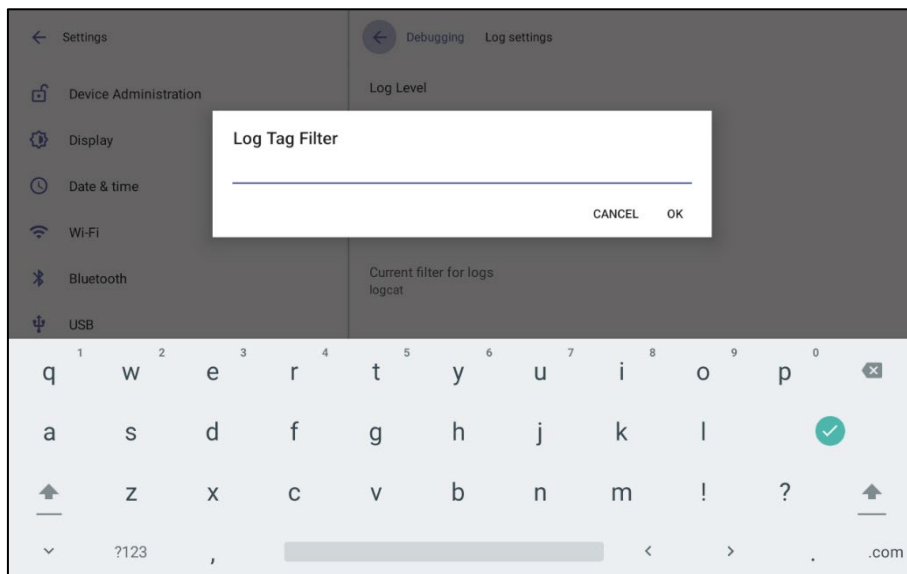

6. Tap **Log Buffer Filter**.

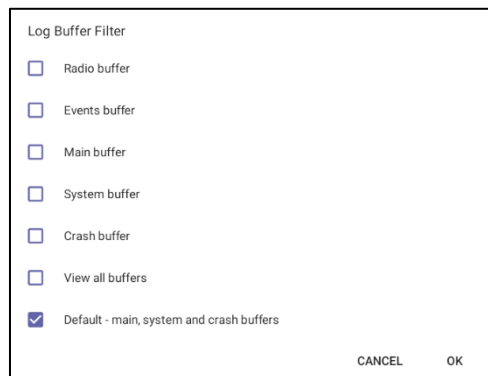

7. Tap the level you require and then tap **OK**.

4.2 Voice Record

Read only setting.

4.3 Remote Logging

Remote Logging via Syslog provides information relevant to device issues (not Teams application issues). When performing Remote Logging via Syslog, the logs are collected in real time.

➤ **To configure remote logging capability:**

1. Tap **Remote logging**.

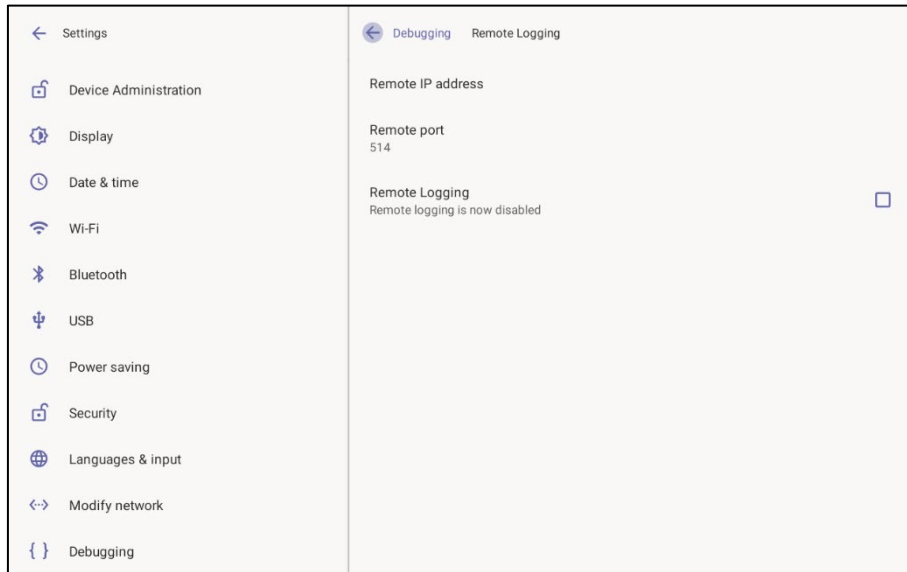

2. Tap **Remote IP address**.

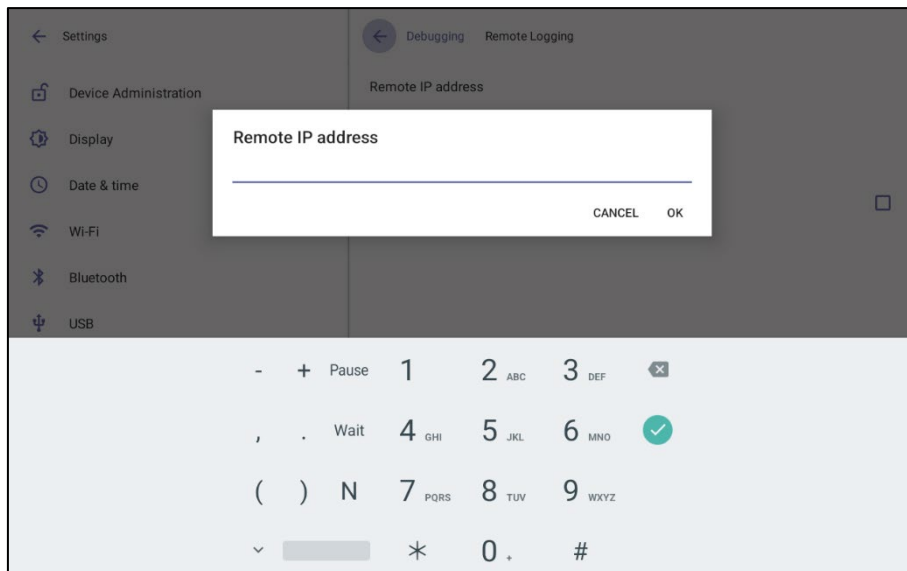

3. Enter the IP address using the virtual keyboard, tap **OK** and then tap **Remote port**.

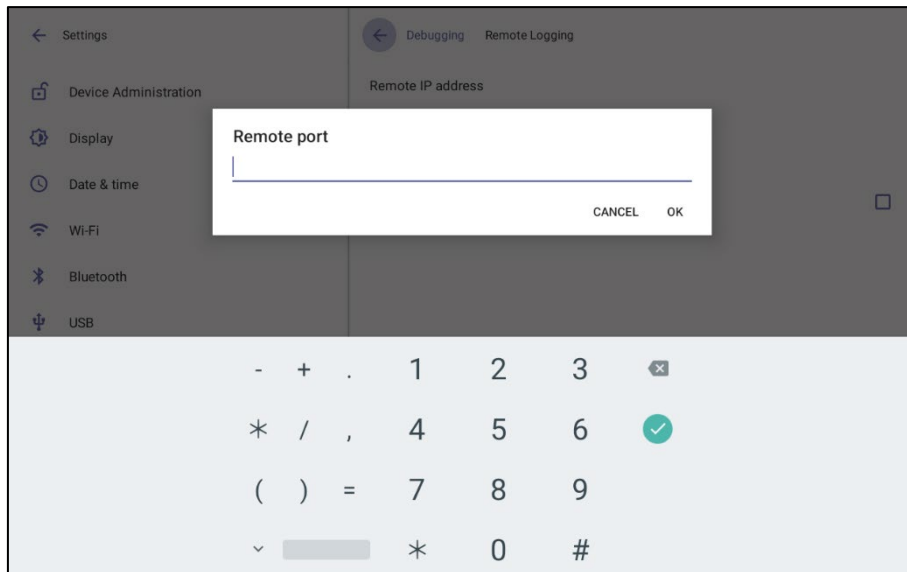

4. Enter the number of the remote port using the virtual keyboard and then tap **OK**.

4.4 Diagnostic Data

Network administrators can get diagnostics information to facilitate debugging.



Note: Administrators who need to get diagnostics info from the device can dump the logs to the phone's Secure Digital (SD) Card and then later collect them using Secure Copy Protocol (SCP) based on Secure Shell (SSH) protocol. Whenever an issue occurs, the administrator can dump the logs into the SD Card.

- **To get diagnostic data:**
- Tap **Diagnostic data**.



4.5 Reset configuration

Admins can get the device to perform a restore to default factory settings.

- **To reset configuration:**
- Tap **Reset configuration**.

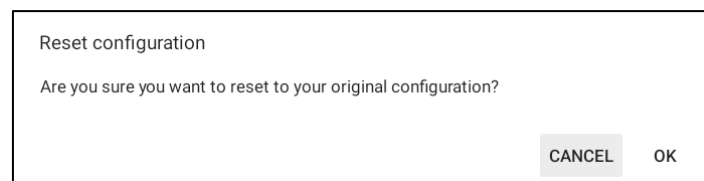

4.6 User Data Reset

RX-PANEL provides a **User data reset** option that is similar to factory reset except that this option preserves predefined data after firmware upgrade.

➤ **To access the functionality:**

- Tap User data reset.

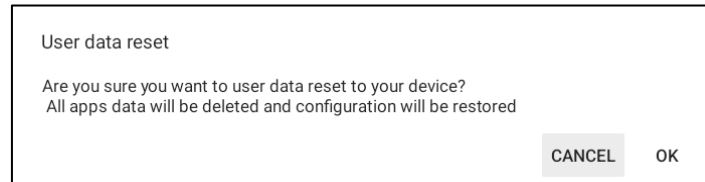

Note: After 'User data reset', network settings are preserved.

4.7 Restart Teams App

Refreshes the device's user interface.

4.8 Debug Recording

Admins can opt to get audio debug recording logs from the device screen. The purpose of these logs is for issues related to media.

➤ **To get audio debug recording logs:**

1. Tap **Debugging > Debug Recording**.

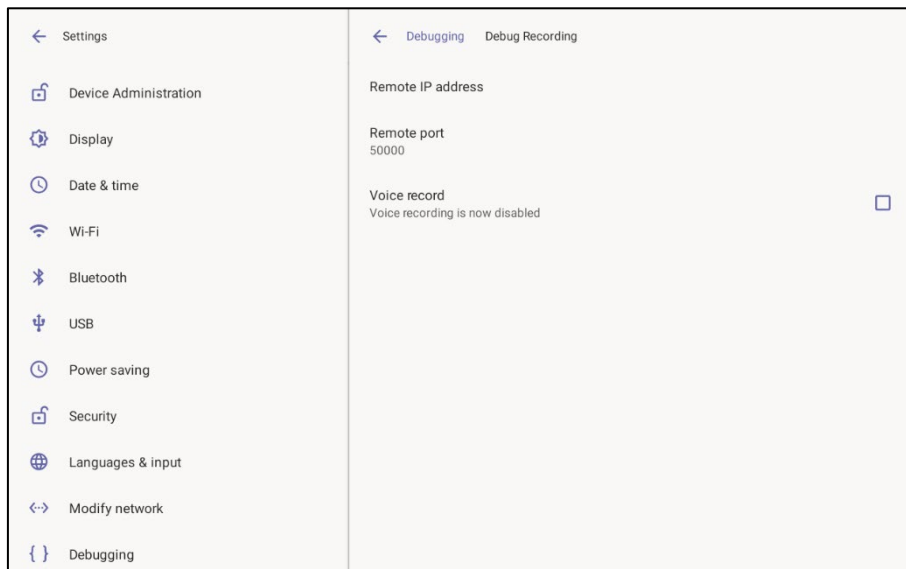

2. Tap **Remote IP address**.

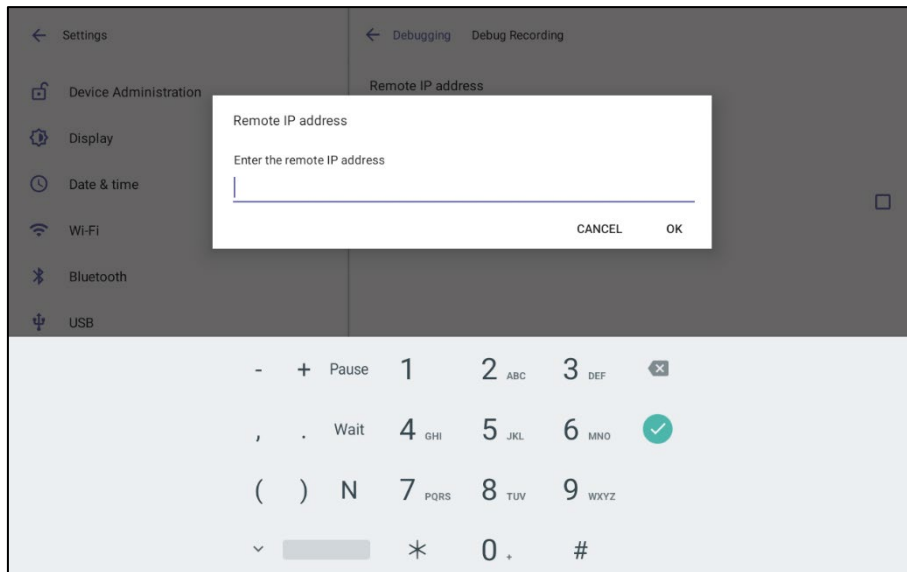

3. Enter the remote IP address, tap **OK** and then tap **Remote port**.

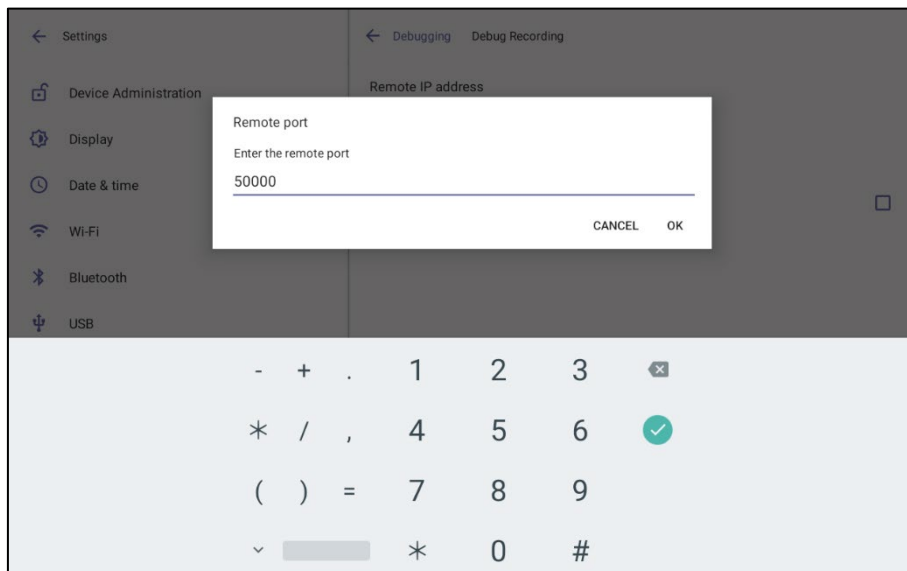

4. Enter the remote port and then tap **OK**.

4.9 Erase all data (Factory Reset)

Admins can get the device to perform a restore to default factory settings.

➤ **To erase all data:**

- Tap **Erase all data**.



4.10 ADB

Admins can get logs using UUID over ADB shell.



Note: To use this method of getting new logs, Android Debug Bridge (ADB), a command-line utility included with Google's Android SDK, must be installed on your PC.

4.11 SSH

Admins can activate a recording using AudioCodes' SSH protocol based Android Device Utility. See [here](#) for more information.

4.12 Screen Capture

Admins can grab a screen capture using AudioCodes' SSH protocol based Android Device Utility. See [here](#) for more information.

4.13 Remote Packet Capture

Admins can capture traffic using 'rncapd' network sniffer application. The 'rncapd' (Remote Packet Capture) network sniffer application allows the admin to analyze and debug Android traffic on their desktop PC using the app's integral SSH server. SSH is by default disabled and can be enabled with admin permission in the device screen.

4.14 Enabling Advanced Meeting Functions

➤ **To enable advanced meeting functions:**

1. Click the **Device Pairing** option in 'Teams Admin Settings' menu and select your device (to pair it at the Teams level):

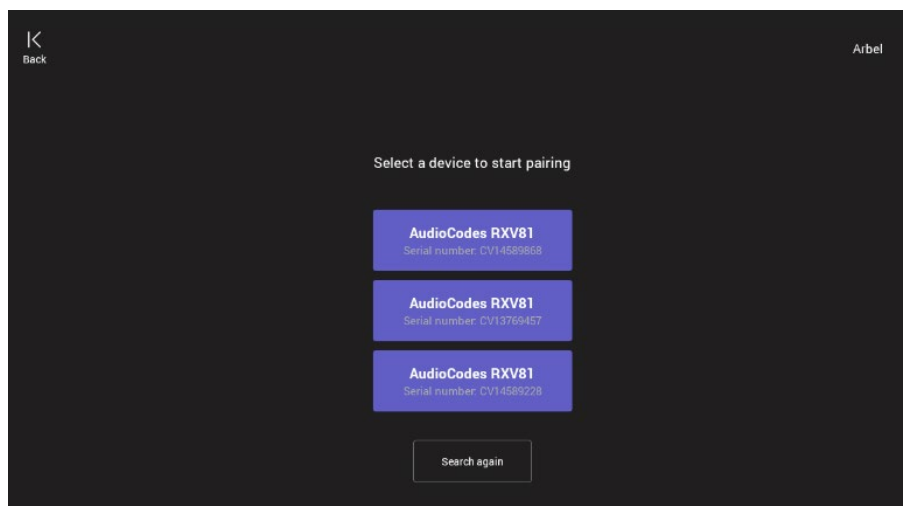

2. Click the **Wallpapers** option to select a wallpaper of your choice.

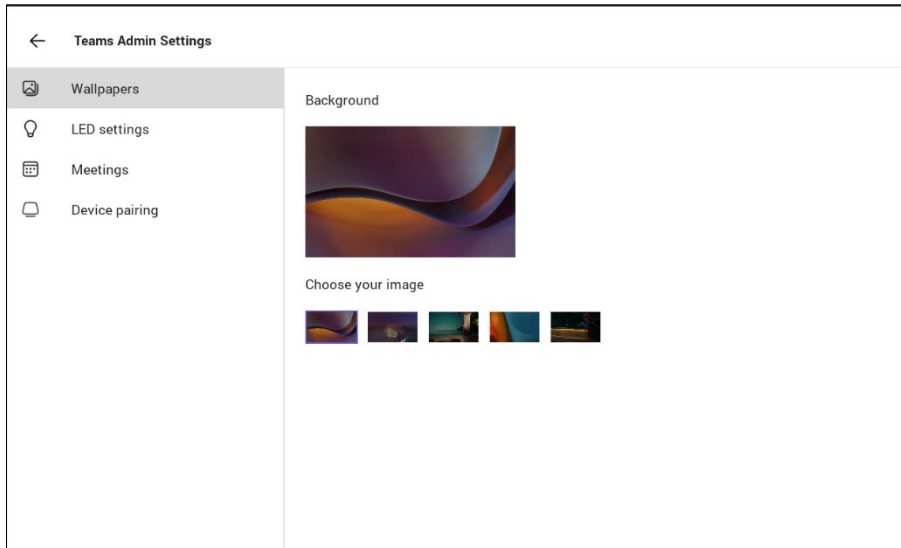

3. Click the **LED settings** option to select the LED color indicating busy state.

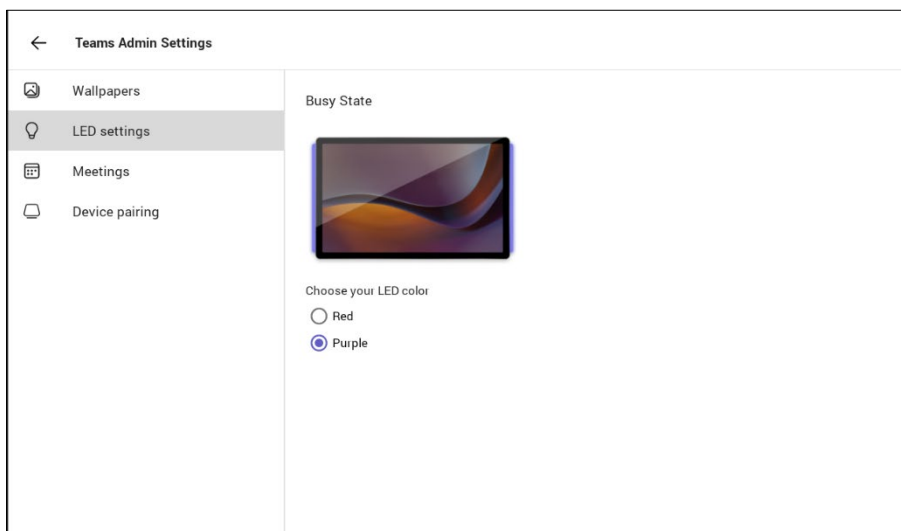

4. Click the **Meetings** option to define advanced meeting check-in functions.

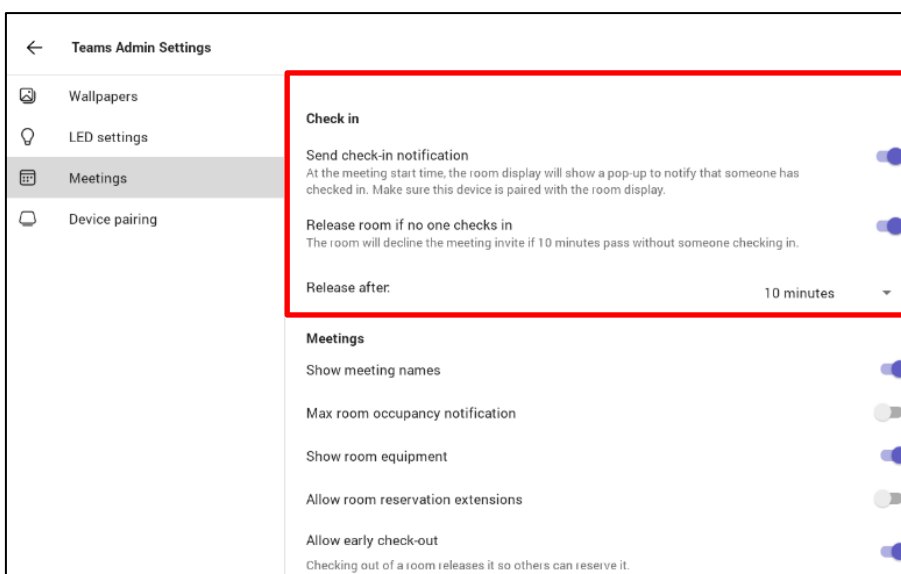

This page is intentionally left blank.

International Headquarters

1 Hayarden Street,
Airport City
Lod 7019900, Israel
Tel: +972-3-976-4000
Fax: +972-3-976-4040

AudioCodes Inc.

80 Kingsbridge Rd.,
Piscataway, NJ 08854, USA
Tel: +1-732-469-0880
Fax: +1-732-469-2298

Contact us: <https://www.audiocodes.com/corporate/offices-worldwide>

Website: <https://www.audiocodes.com/>

©2023 AudioCodes Ltd. All rights reserved. AudioCodes, AC, HD VoIP, HD VoIP Sounds Better, IPmedia, Mediant, MediaPack, What's Inside Matters, OSN, SmartTAP, User Management Pack, VMAS, VolPerfect, VolPerfectHD, Your Gateway To VoIP, 3GX, VocaNom and AudioCodes One Voice are trademarks or registered trademarks of AudioCodes Limited. All other products or trademarks are property of their respective owners. Product specifications are subject to change without notice.

Document #: LTRT-18290